

Operating Manual

64 Port High power amplifier

Catalog

Using Safety Precautions.....	1
Application	2
Feature	2
Description:	2
Block Diagram	2
Optical characteristics	4
Environmental characteristics	4
Electrical Characteristics.....	4
Starting up.....	5
Equipment Powered Instructions	5
LED/ Key Description	5
Display Menu Description.....	5
Indicator.....	6
Interface	7
Web.....	8
Login	8
Device Infomation	9
Network Config.....	9
User Management	10
SNMP Config	12
SNMP	13
Laser Safety Information	13
Order Information	13

Using Safety Precautions

Before installing and using this product, please read the following carefully. The Company does not assume any responsibility for any loss due to security breaches caused.



Lasers and erbium-doped fiber amplifier output power laser radiation is not visible, can not look directly at the device connector end when it works to avoid burning eyes and skin.



Equipment includes precision optics, in order to avoid damage to the severe impact of its constitution, please avoid excessive vibration and impact. Pigtail easily sacrificed, so be careful.



Equipment containing electrostatic sensitive devices, handle it carefully and make sure the ground is good, the power supply is normal.

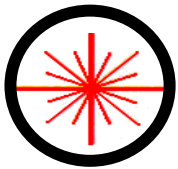

Attention of optic fiber end face:

- 1、 Before using, please be sure to keep the input and output end face of the optic fiber clean, especially if the output end face is dirt, then it is easy to make the output end face burned and the output power will be decreasing. When cleaning the optical fiber end face or insert patch cords, please turn off the input light first.
- 2、 The correct order of plugging optical port is:
Inserting: first insert optical patch cord of output port, then insert optical patch cord of input port.
Pulling out: first pull optical patch cord of input port, then pull optical patch cord of output port.
- 3、 This kind amplifier is a high precision and high stability product, in order to have high stability output power, please use optical patch cord with good quality and which connectors are match with the device to connect with the output port. In principle, the optical patch cord should be as short as possible, and do not let it voluntary movement.



If there are any questions, please contact our company. Do not disassemble the module, otherwise it will cause irreparable damage

Application

- ◆ Analog CATV Transmission
- ◆ FTTH Optical Access
- ◆ Optical Distribution
- ◆ Free Space Optical
- ◆ R&D and Training

Feature

- ◆ High Power: Up to 2W total, 1 Unit for 2000~4000 optical node
- ◆ Low Noise Figure: Below 5.5dB (+5dBm input)
- ◆ Er Yb co-doped DCF Amplify Technology: Patent Pump Dump Technology
- ◆ Low CSO: <-70dBc
- ◆ 23dBm×N, 20dBm×N or 17dBm×N output is optional
- ◆ Controllability and maneuverability: Dual CPU to deal Control loop and Communication separately
- ◆ High Stability And Reliability: MTTF > 150000 Hours
- ◆ Redundancy Hot Swap power module: 110/220VAC and 48VDC can plug Mix
- ◆ Perfect Network Interface: Ethernet
- ◆ Support SNMP network management
- ◆ Intelligent Temperature Control System: using a dedicated Temperature control chip which make cooling and power loss reduce 30% than competitors
- ◆ Output Power can be Adjustable by network and manual
- ◆ Integrated 1310nm, 1490nm, 1550nm WDM (Optional)
- ◆ OEM, Module is available

Description

The product is high output power C-Band Er-Yb co-doped double cladding optical fiber amplifier. The key components of the product are high reliability multimode PUMP laser and the double cladding optical fiber. A proprietary ATC (Automatic Temperature Control) and APC (Automatic Power Control) circuit insures the high stability and reliability output power, the unique optical circuit design ensures the excellent optical performance. The high stability and high precision MPU system to ensure the control, adjustment and display are intelligent and easy.

This amplifier employ double cladding Erbium Ytterbium co-doped fiber, and employ the high power multimode pump, with a 10 times Conversion efficiency higher than the single mode general technology, and therefore have a lower relative cost and more compact size and lower power consumption, in particular, for FTTH or FTTB or other large distribution system applications.

Employ intelligent temperature control system: (1)Adopt special temperature control circuit, heat radiating and power consumption can be reduced 30%, (2)The professional air flow design can also ensure the best temperature stability, at the same time powerful fan will start when the case temperature is over 45°C, meanwhile it will stop as the temperature is under 40°C. The technology makes sure the thermal stability of system and fan' s long life.

Intelligent network management system. Perfectly network interface: Ethernet network, and the open network management interface ensure the connectivity with all other network management system.

These products are widely used in CATV transmission system and the high power distributing system FTTH requirement. It can be used for CATV analog/digital signal distribution, or match with PON system to construction the triple network integration. (Triple wavelength WDM is optional)

Block Diagram

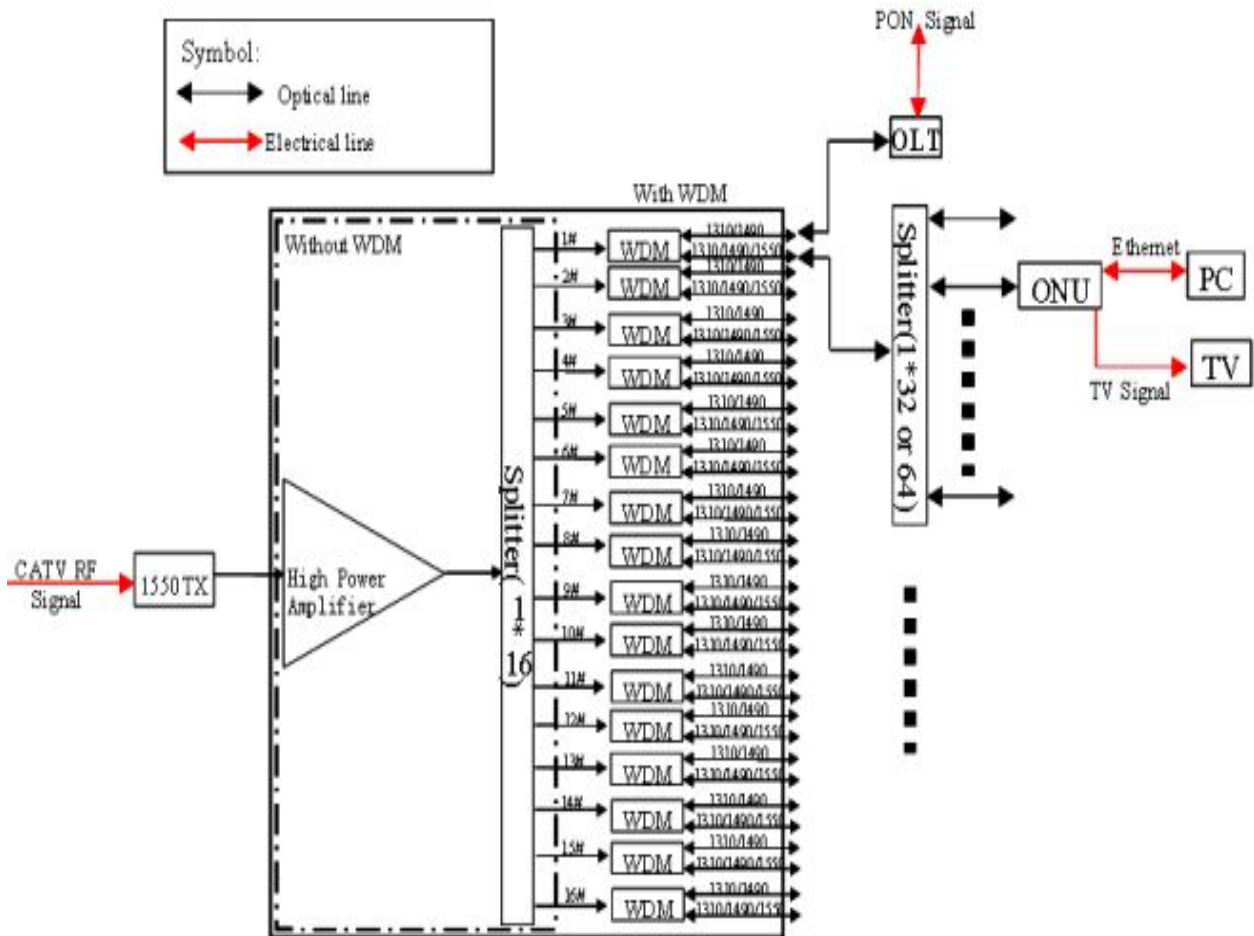
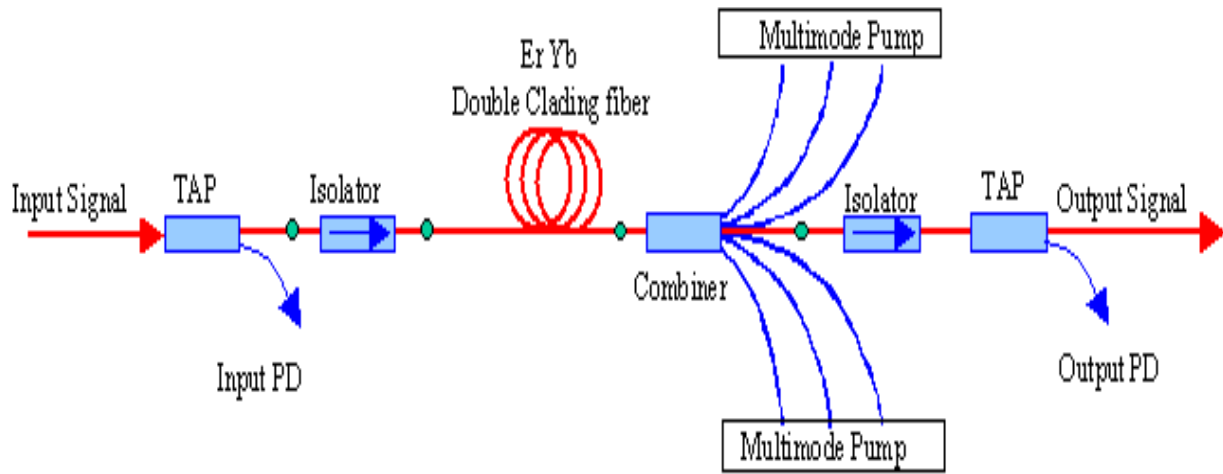

EPON/GPON

Optical characteristics

Parameter	Symbol	MIN	TYP	MAX	UNITS
Operating Wavelength	λ_c	1540	1550	1565	nm
Saturated Output Power <i>Note1</i>	Po	13	-----	33	dBm
Input Power	Pi	-3	-----	+10	dBm
Gain	G	-----	-----	30	dB
Noise Figure <i>Note2</i>	NF	-----	-----	5.5	dB
Output Power Stability	ΔP_o	-----	± 0.05	± 0.2	dB
Input Isolator	ISOi	30	-----	-----	dB
Output Isolator	ISOo	30	-----	-----	dB
Input Pump Leakage	PLi	-----	-----	-35	dBm
Output Pump Leakage	PLo	-----	-----	-45	dBm
Return Loss	RL	-----	-----	-45	dB
Polarization Dependent Gain	PDG	-----	-----	0.3	dB
Polarization Mode Dispersion	PMD	-----	-----	0.5	ps

Note 1: Optional

Note 2: Tested at +5dBm Input

Environmental characteristics

Parameter	Symbol	MIN	TYP	MAX	UNITS
Operating Temperature	T _w	-5	-----	60	°C
Storage Temperature	T _s	-40	-----	80	°C
Humidity <i>Note</i>	-----	10	-----	90	%

Note: No Condensate

Electrical Characteristics

Parameter	Symbol	MIN	TYP	MAX	UNITS
Power Supply (1)	V _{ps}	170	-----	264	VAC
Power consumption	P	-----	-----	50	W

1: 110VAC, 220VAC and -48VDC is optional, and duplicate supply is optional.

Starting up

Before starting up, Please check the input voltage to the rated input voltage, grounding is good. The product adopts independent 220 VAC power supply.

Equipment Powered Instructions

Special Note:

1. The power module must be properly inserted in the device, so it can be supplied power.
2. Do not insert the charged power module into the device directly.

LED/ Key Description

- ▲ key : Upper button. Press this button can check each parameter of products from bottom to top.
- ▼ key : Down button. Press this button can check each parameter of products from top to bottom.
- ▶ key : Menu button. Press it can enter the menu.
- ◀ key : Return button. Press it can return to the standby screen.

Display Menu Description

- (1) Display device start up process when power on:

High Power Amplifier

- (2) Press the Menu button to display products model:

MODEL : EDFA 1550

- (3) Press the down button to display internal temperature:

INTERNAL TEMP **°C

- (4) Press the down button to display the current of pump 1:

LD1 CURRENT ***MA

- (5) Press the down key to display the cooling current of pump 1:

TEC1 CURRENT ***MA

- (6) Press the down button to display the current of pump 2:

LD2 CURRENT *.* A

(7) Press the down button to display the temperature of pump 2:

LD2	COOLER	**.* °C
------------	---------------	----------------

(8) Press the down button to display the operating current of pump 3:

LD3	Current	*.* A
------------	----------------	--------------

(9) Press the down button to display the temperature of pump tube 3:

LD3	COOLER	**.*°C
------------	---------------	---------------

(10) Press the down button to display input optical power:

Input	*.**mW	*.*dBm
--------------	---------------	---------------

(11) Press the down button to display output optical power:

OUTPUT	***MW	**.*DBM
---------------	--------------	----------------

(12) Press the down button to display working status:

AGC	Conerol	***
------------	----------------	------------

In this screen, press the Menu button to display "ON" opens AGC function . If a high-power pump is damage, the other pump will increase the pumping power automatically to maintain the stability of output power. Press the Return key to display "OFF", this function is off.

(13) Press the down button to display the status of the pump:

PUMP	CONTROL	**
-------------	----------------	-----------

In this screen, press the Menu button to display "ON" pump working.
Press the Return key to display "OFF" pumped off.

Indicator

- **Pump1:** Pump 1 indicator off is normal, pump 1 flashing is alarming.
- **Pump2:** Pump 2 indicator off is normal, pump 2 flashing is alarming.
- **Alarm:** Alarm Indicator: input and output light turns red when alarming.

- **AGC** : When the AGC function is turned on the light turns green.

Interface

Front-Panel、 Back-Panel

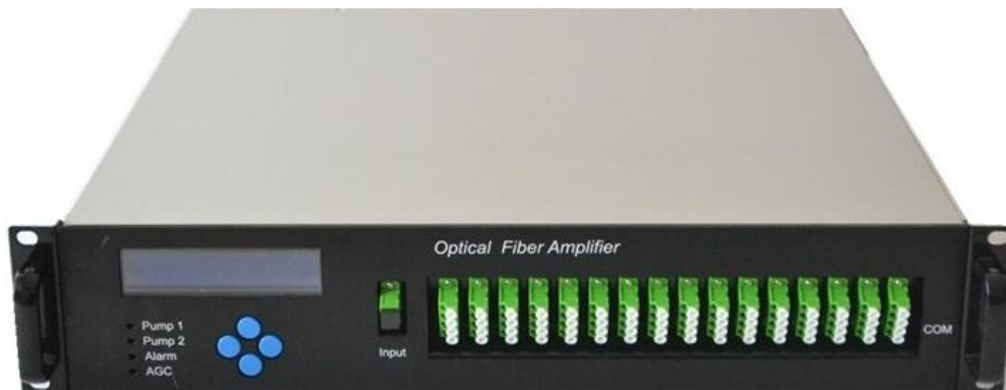

Connectors

	Description
Input	Optical input port
1~16	Optical output ports
RJ45	Ethernet control port
Power1/2	Power input 110/220V AC
Reset (optional)	Short press: reboot net control board Long press: reset all net parameter to default

Web Management

Login

1. Open Internet Explorer;
2. Input IP address into address box;
3. After the [Login] page have shown up, input UserName and password;
4. Press Login button;

Note:

*1: Default IP address is 192.168.1.1 which can be modified at [Network Config] web page;

*2: Default UserName and password both are admin which can be modified at [User Management] web page;

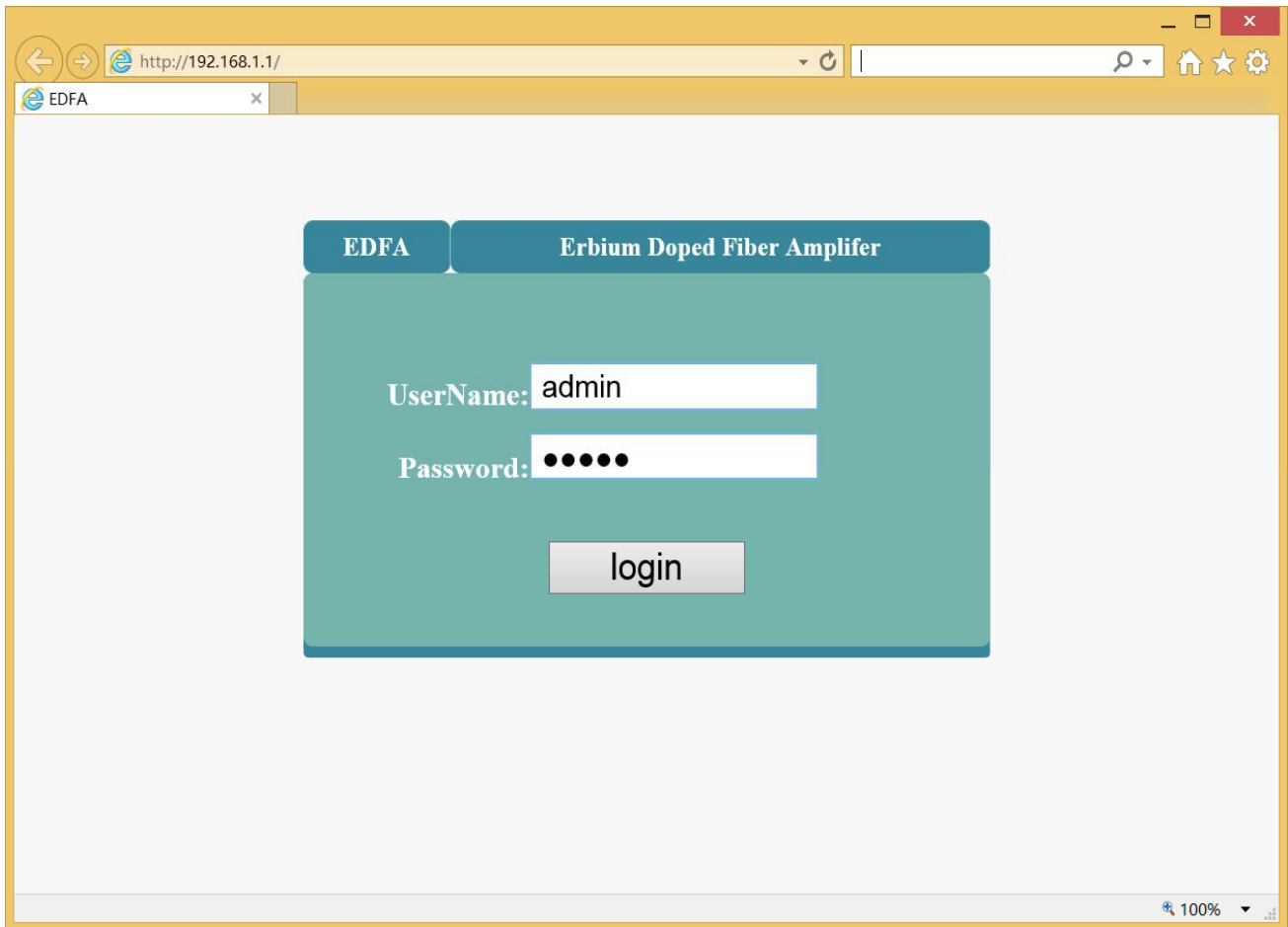

Device Infomation

After at successful login, the [Device Information] page will show up. There're three sections.

1. Device

PowerMode: The name of electrical power source is using;

LaserCount: Total number of laser pump is used;

LaserType: 01=standard pump;

Temperature: The case temperature of the device;

InputPower: The input optical power of the device;

OutputPower: The output optical power of the device;

SystemStatus: OK=every thing goes well; otherwise the error message will be shown;

2. Laser

Bias: the current of main pump;

TEC: the current of the Thermo Electric Cooler;

Temperature: the core temperature of the pump;

3. Power

The main electrical power and backup electrical power supply status;

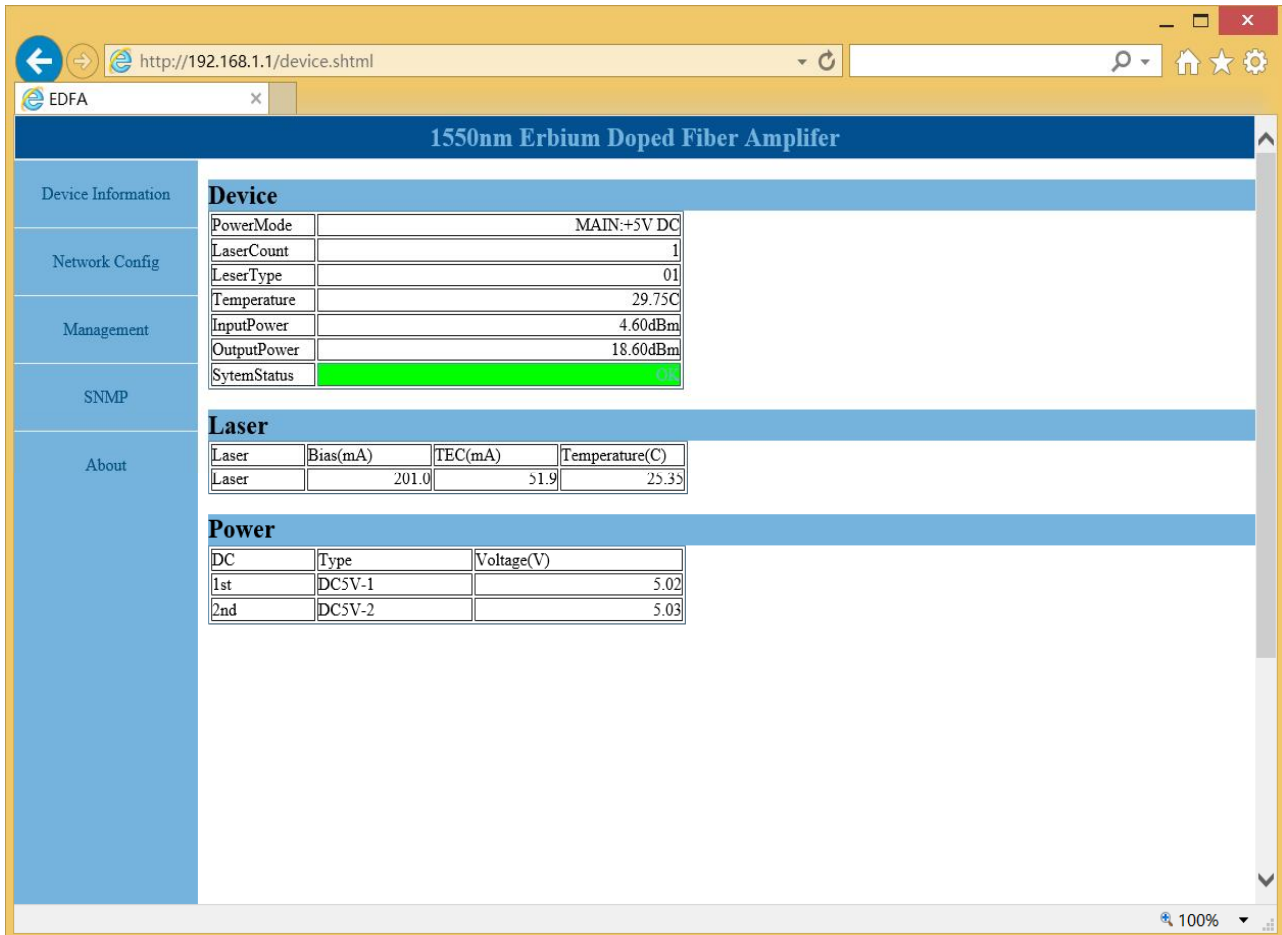

The screenshot shows a web browser window with the URL `http://192.168.1.1/device.shtml`. The page title is "1550nm Erbium Doped Fiber Amplifier". The interface is divided into a left sidebar with navigation options: "Device Information", "Network Config", "Management", "SNMP", and "About". The main content area displays three sections:

- Device**: A table with the following data:

PowerMode	MAIN:+5V DC
LaserCount	1
LaserType	01
Temperature	29.75C
InputPower	4.60dBm
OutputPower	18.60dBm
SytemStatus	OK
- Laser**: A table with the following data:

Laser	Bias(mA)	TEC(mA)	Temperature(C)
Laser	201.0	51.9	25.33
- Power**: A table with the following data:

DC	Type	Voltage(V)
1st	DC5V-1	5.02
2nd	DC5V-2	5.03

Network Config

This page modifies the network parameters.

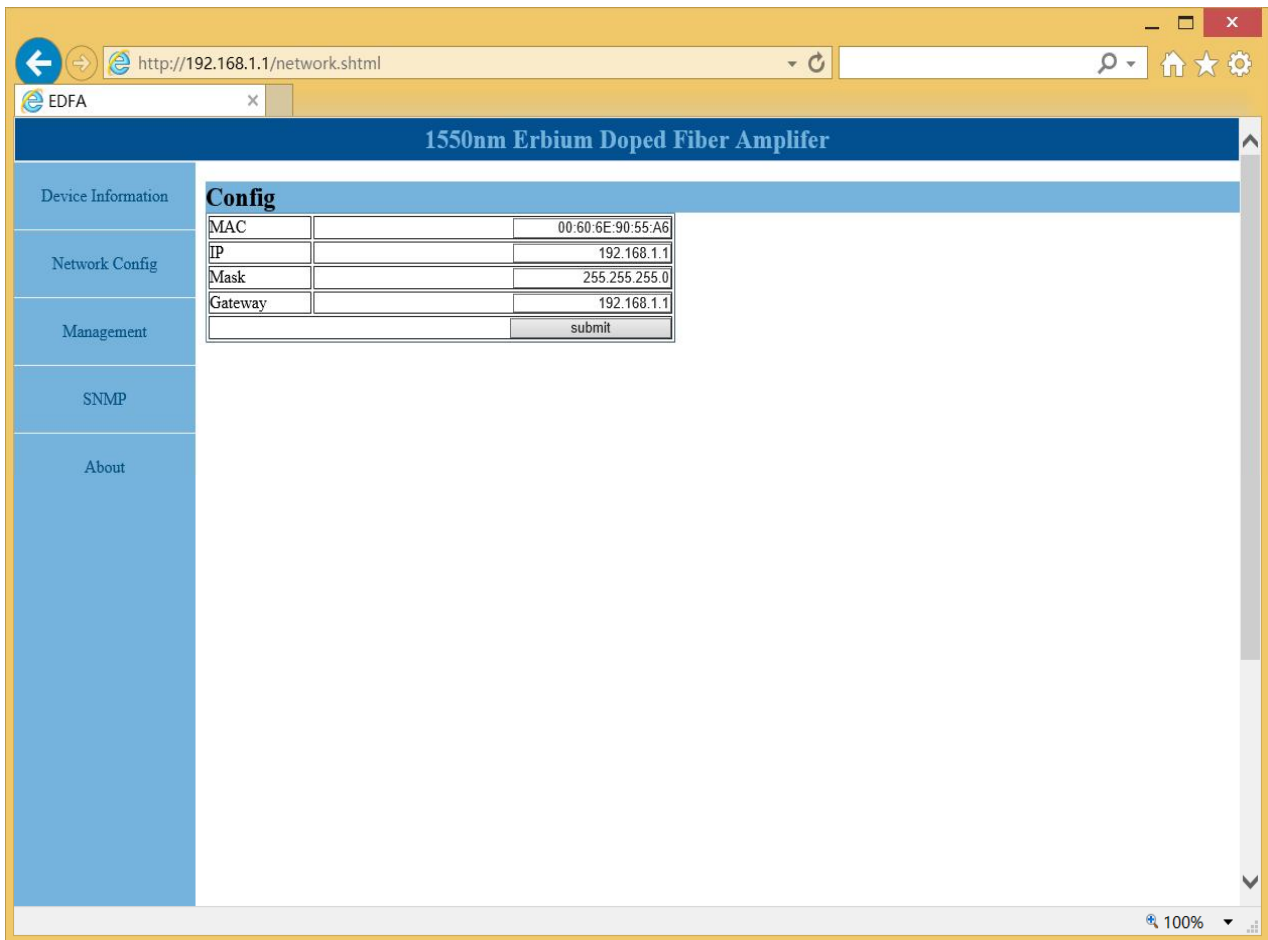

User Management

This page modifies the login account. You can change the user name and password here.

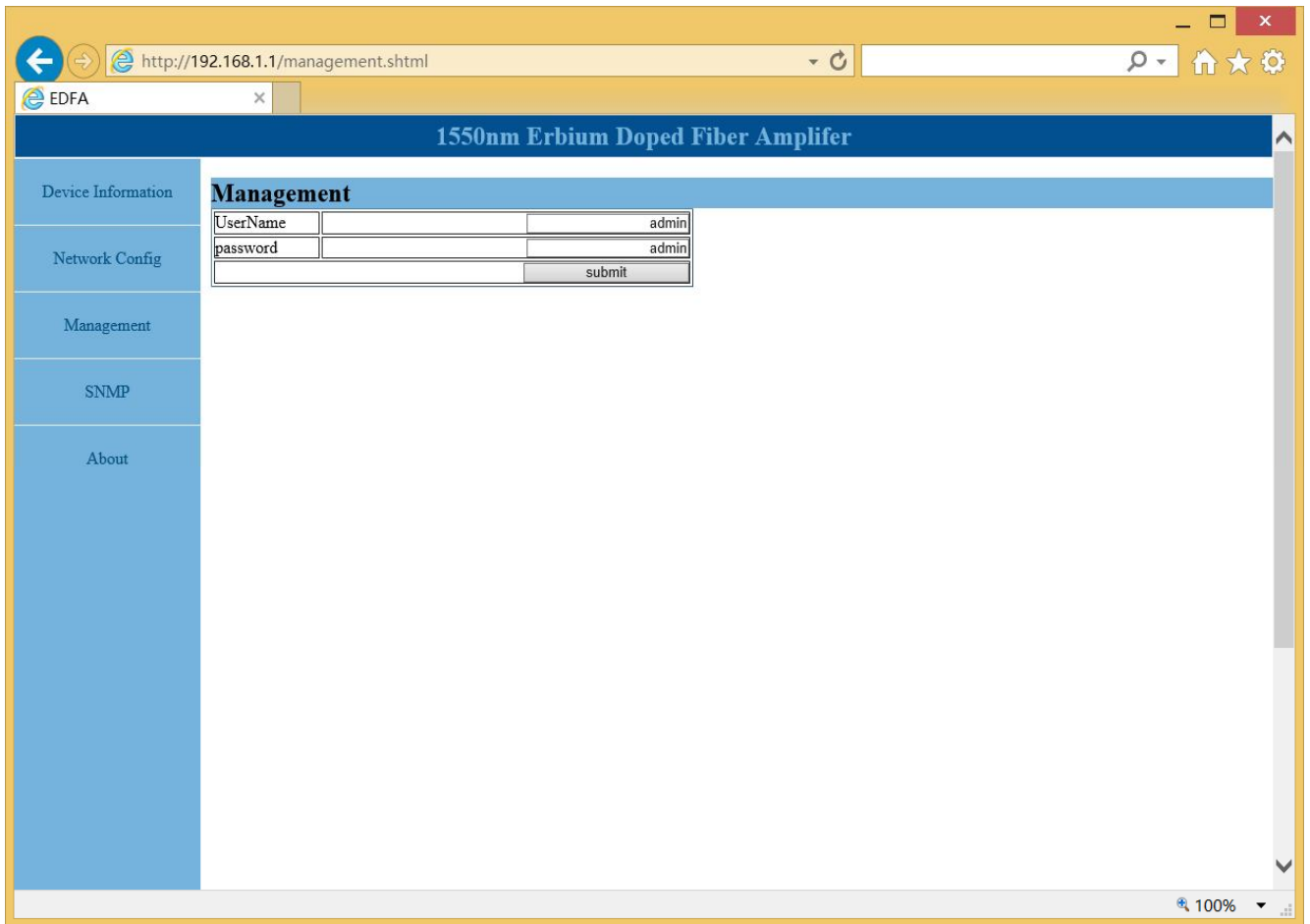

EDFA

1550nm Erbium Doped Fiber Amplifier

Device Information

Network Config

Management

SNMP

About

Management

UserName	<input type="text" value="admin"/>
password	<input type="text" value="admin"/>
<input type="button" value="submit"/>	

100%

SNMP Config

This page modifies the SNMP Community. You can changed the community of read or write here.(Only read community is using.)

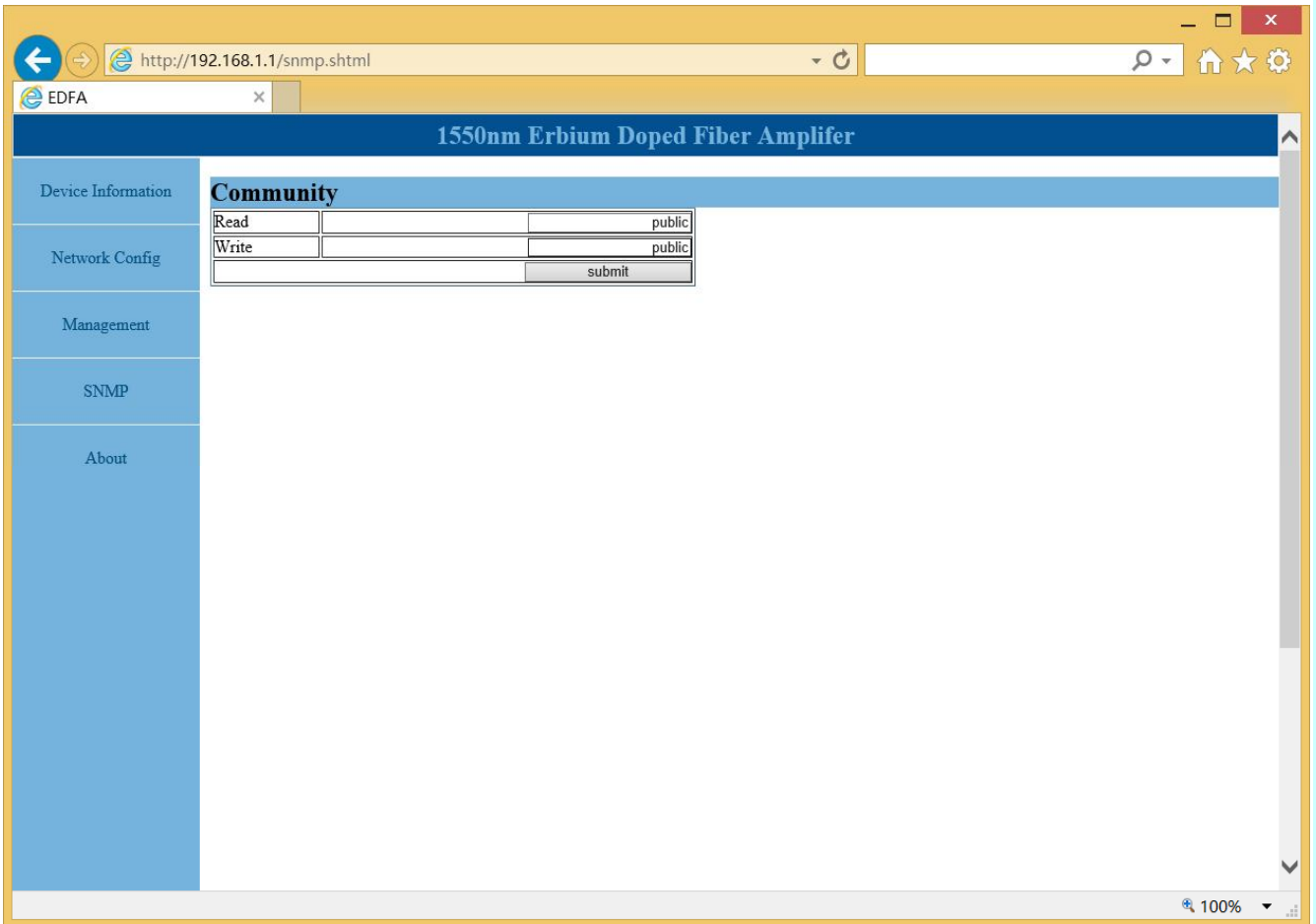

Community		
Read	<input type="text"/>	public
Write	<input type="text"/>	public
<input type="button" value="submit"/>		

SNMP Management

SNMP Version 1 protocol is supported. The device related mib are defined as below.

mib	function
1.3.6.1.4.1.17409.1.11.2.0	Optical Input Power value*0.1dBm
1.3.6.1.4.1.17409.1.11.3.0	Optical Output Power value*0.1dBm
1.3.6.1.4.1.17409.1.11.4.1.2.1	Bias Current.1 value*1mA
1.3.6.1.4.1.17409.1.11.4.1.2.2	Bias Current.2 value*1mA(Reserved)
1.3.6.1.4.1.17409.1.11.4.1.2.3	Bias Current.3 value*1mA(Reserved)
1.3.6.1.4.1.17409.1.11.4.1.3.1	Tec Current.1 value*0.1A
1.3.6.1.4.1.17409.1.11.4.1.3.2	Tec Current.1 value*0.1A(Reserved)
1.3.6.1.4.1.17409.1.11.4.1.3.3	Tec Current.2 value*0.1A(Reserved)
1.3.6.1.4.1.17409.1.11.4.1.4.1	Pump Temperature.1 value*0.1 deg
1.3.6.1.4.1.17409.1.11.4.1.4.2	Pump Temperature.1 value*0.1 deg(Reserved)
1.3.6.1.4.1.17409.1.11.4.1.4.3	Pump Temperature.2 value*0.1 deg(Reserved)
1.3.6.1.4.1.17409.1.11.7.1.2.1	DCPower Voltage.1 value*0.1V
1.3.6.1.4.1.17409.1.11.7.1.2.2	DCPower Voltage.2 value*0.1V
1.3.6.1.4.1.17409.1.3.1.13.0	Internal Temperature value*1deg
1.3.6.1.4.1.17409.1.3.3.2.2.1.12.1	Device Temperature value*1deg

Laser Safety Information

Class IV laser products.

9µm/125µm single-mode fiber pigtail with connector.

Wavelength=0.90~1.68µm

Maximum Power=10W

Caution: Use of controls, adjustments, and procedures other than those specified herein may result in hazardous laser radiation exposure.



Order Information

Category	Application	Input Power	Output Power	ports	Power supply1	Power supply2	Interface	Network Management
EDFA-1500	1	X	20	64	2	4	2	0
1U/ 2U/3U Rack	1: CATV	1-5~+10dBm;	13:13dBm	1:1 port	1: 110VAC	1: 110VAC	1:SC/UPC	0: None
Dual power	2: DCM	2:+5~+15dBm;	24:24dBm	2:2 port	2: 220VAC	2: 220VAC	2:SC/APC	1: SNMP
supply	3.Telecom single channel	3:0~+10dBm;		4:4 port	4: -48VDC	4: -48VDC	3:FC/UPC	
	4:Telecom DWDM	4:-8~+10dBm;		8:8 port		0: None	4:FC/APC	
	5:Wide Band single Channel	5:-35dBm~-25dBm(16:16 port			5:LC/UPC	
		Pre);		32:32 port			6:LC/APC	
		6:-25dBm~-10dBm(64:64 port				
		Online);						
		7:-10dBm~+6dBm(
		Booster);						
		9:Other						

Note 1: EDFA-1500 for 1U rack, Maxim ports number: 16 (w/ WDM) , or 32 (w/o WDM)

Note 2: High End configure with SNMP Net management.

Note 3: 2U and 3U rack maxim 64 port with WDM